

Work happily



V1.3

naggura'swop

[naggura.com](http://naggura.com)

# Our products



Spa



The Swop S3 Pro Spa is an electrical 3-section table with a one-piece mattress, wooden structure, TwinLift armrest system and heating.

Wood, Metal or Pmma



# Collections

Nordic  
METAL

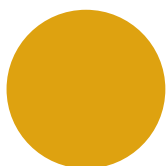

Yellow

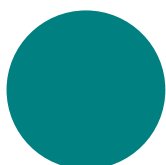

Blue

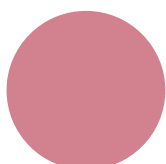

Pink

Foll  
METAL



Ash

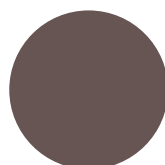

Clay

Iron  
METAL

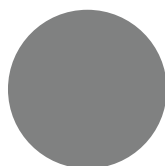

Inox

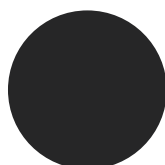

Black

Om  
WOOD



Oak



Wenge

Techno  
PMMA



Fluor



Fuxia



Ice

# SWOP S3 PRO SPA



## Dimensions

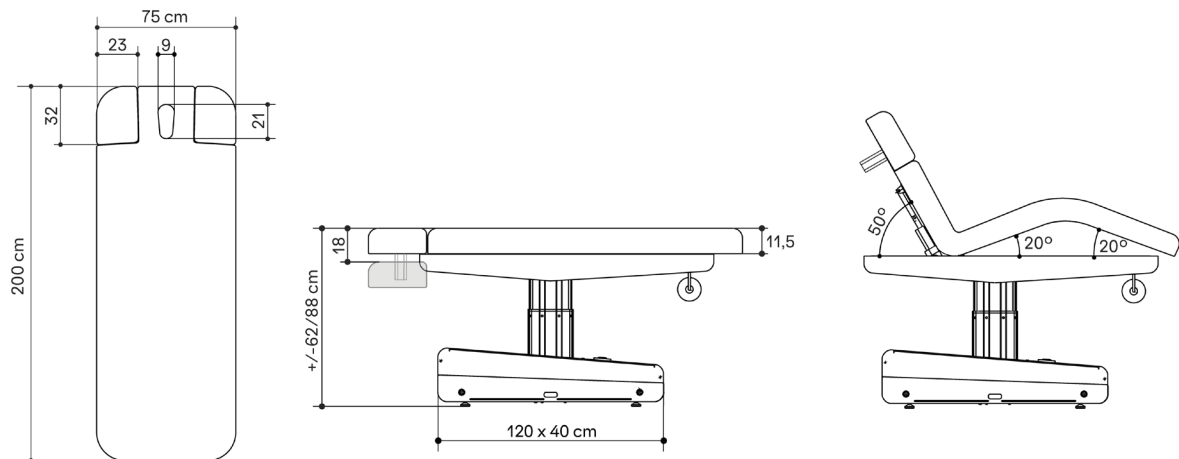

## General specifications

### MOTORS

3 engine (height, footrest, backrest)

### DIMENSIONS (LENGTH X WIDTH)

200 x 75 cm

### HEIGHT (MIN. AND MAX.)

62/88 cm

### WEIGHT

110 kg

### WARRANTY

2 years on table & upholstery

### THICKNESS

11,5 cm (10 cm latex and 1,5 cm wood base)

### DENSITY

30 kg/m<sup>3</sup>

### LIFTING CAPACITY

175 kg

### OPERATION

Hand controller (included)/  
Foot controller (optional)

### POWER SUPPLY

230 V - 50/60 Hz

### MAX. INTENSITY

2 A

### ELECTRIC MOTOR

6.000 N

### FEATURES

TwinLift armrest system  
Heating  
Roll holder

### CUSHION

Upholstery Seamless  
round edges

Naggura Skin upholstery:  
100% vinyl compound in  
white.

Superior abrasion resis-  
tance: >250.000 cycles.  
Protection against germs  
and UV rays.